



Features:

- Universal AC input 90~264VAC
- Built-in active PFC function, high efficiency
- Protections: Short circuit / Overload / Over voltage / Over temperature
- Built-in cooling Fan ON-OFF control
- Low profile 41mm
- Remote control/DC OK/PV/PC/remote sense
- Redundant (for LP-1000R)
- 100% full load burn-in test
- LED indicator for power on
- With 75W auxiliary power which was isolated with main output
- 5 years warranty
- Compliance to IEC/EN/UL 62368-1

Specification

MODEL		LP-1000-12	LP-1000-15	LP-1000-24	LP-1000-36	LP-1000-48
INPUT	VOLTAGE RANGE	90~264VAC 127~370VDC(refer to 'static characteristic')				
	FREQUENCY RANGE	47~63Hz				
	POWER FACTOR(Typ.)	PF>0.95/230VAC PF>0.99/115VAC at full load				
	EFFICIENCY(Typ.)	92%	93%	94%	94%	94%
	AC CURRENT(Typ.)	12A/115VAC 6A/230VAC				
	INRUSH CURRENT(Typ.)	20A/115VAC 40A/230VAC (cold start)				
	LEAKAGE CURRENT	<0.75mA/240VAC				
OUTPUT	DC VOLTAGE	12V	15V	24V	36V	48V
	RATED CURRENT	80A	64A	42A	28A	21A
	CURRENT RANGE	0~80A	0~64A	0~42A	0~28A	0~21A
	RATED POWER	960W	960W	1008W	1008W	1008W
	RIPPLE&NOISE (max.)	150mVp-p	150mVp-p	240mVp-p	240mVp-p	300mVp-p
	VOLTAGE ADJ.RANGE	6~14.4V	14.3~15.8V	12~28.8V	18~43.2V	24~57.6V
	VOLTAGE TOLERANCE	±1%	±1%	±1%	±1%	±1%
	LINE REGULATION	±0.5%	±0.5%	±0.5%	±0.5%	±0.5%
	LOAD REGULATION	±0.5%	±0.5%	±0.5%	±0.5%	±0.5%
	SETUP, RISE TIME	1000ms,50ms/230VAC 1000ms,50ms/115VAC				
	HOLD UP TIME(Typ.)	8ms/230VAC 8ms/115VAC				
PROTECTION	OVER LOAD	105%~120% rated output power Protection type: constant current>2s, then Shutdown, recovers automatically after repower on				
	OVER VOLTAGE	15~18V	16.5~19.5V	27.6~32.4V	39.6~46.8V	56.6~66.2V
	OVER TEMPERATURE	Protection type: Shutdown, recovers automatically after temperature goes down				
FUNCTION	FAN ON/OFF CONTROL(Typ.)	RTH2≥50°C FAN ON, ≤40°C FAN OFF				
	REMOTE CONTROL(CN1)	Power on: voltage between RC+ and RC- is 0-0.8V; Power off: voltage between RC+ and RC- is 4-10V				
	DC OK	Voltage between DC OK and VO- goes high after power set up; The voltage goes low when Vo below 80% of adj. voltage value. Internal pull-up voltage is 5.7V, internal pull-up resistor is 100Ω				
	OUTPUT VOLTAGE PROGRAMMABLE(PV)	Adjustment of output voltage is allowable to 50~120% of nominal output voltage When users use PV function, CN3 should not be shorted by jumper. Refer to the Function Manual.				
	OUTPUT CURRENT PROGRAMMABLE(PC)	Adjustment of constant current level is allowable to 20~100% of rated current. When users use PC function, CN4 should not be shorted by jumper. Refer to the Function Manual.				
	REMOTE SENSE	Compensate voltage drop on the load wiring up to 0.3V. Refer to the Function Manual.				
	AUXILIARY POWER	With 75W auxiliary power which was isolated with main output, 24V/3.13A tolerance±2% The auxiliary power output voltage also can be customized.				
	REDUNDANT(LP-1000R)	For parallel connection protection: For parallel applications, when one PSU cannot work, the another one will be automatically enabled. This can prevent the system crash, and provide the reliability of system				
ENVIRONMENT	WORKING TEMP., HUMIDITY	-30~+70°C (Refer to "Derating curve") , 20~90%RH non-condensing				
	STORAGE TEMP., HUMIDITY	-40~+85°C, 10~95%RH				
	TEMP. COEFFICIENT	±0.03%/°C (0~50°C)				
	VIBRATION	10~500Hz, 2G 10min./1 cycle, each along X、Y、Z axes				

Safety and electromagnetic compatibility	Safety standards	Refer to UL62368-1,TUV EN62368-1,CCC GB4943.1		
	Withstand voltage and isolation resistance	I/P-O/P: 3KVac; 100MΩ / 500Vdc / 25°C / 70%RH		
		I/P-FG: 2KVac; 100MΩ / 500Vdc / 25°C / 70%RH		
		O/P-FG: 0.5KVac; 100MΩ / 500Vdc / 25°C / 70%RH		
	Electromagnetic	Parameter	Standard	Test Level / Note
		Conducted emission	BS EN/EN55032(CISPR32),FCC PART 15 / CISPR22 ,GB9254.1	Class B
		Radiated emission	BS EN/EN55032(CISPR32),FCC PART 15 / CISPR22 ,GB9254.1	Class B
		Harmonic current	BS EN/EN61000-3-2,GB17625.1	Class A
		Voltage flicker	BS EN/EN61000-3-3	----
	Electromagnetic compatibility immunity	BS EN/EN55035		
		Parameter	Standard	Test Level /Note
		ESD	BS EN/EN61000-4-2	Level 4, 8KV air, Level 2, 4KV contact, criteria A
		RF field susceptibility	BS EN/EN61000-4-3	Level 3, criteria A
		EFT bursts	BS EN/EN61000-4-4	Level 3, criteria A
Surge susceptibility		BS EN/EN61000-4-5	Level 3, 1KV/L-N, 2KV/L/N-FG criteria A	
Conducted susceptibility		BS EN/EN61000-4-6	Level 3, criteria A	
Magnetic field immunity		BS EN/EN61000-4-8	Level 4, criteria A	
	Voltage dips and interruptions	BS EN/EN61000-4-11	>95% dip 0.5 periods, 30% dip 25 periods , >95% interruptions 250 periods	
OTHERS	MTBF	≥600Khrs MIL-HDBK-217F(25°C)		
	DIMENSION	240*115*41mm(L*W*H)		
	PACKING	1.5Kg; 9pcs/ 14.5Kg/ 0.94CUFT		
NOTE	<ol style="list-style-type: none"> All parameters NOT specially mentioned are measured at 230VAC input, rated load and 25°C of ambient temperature. Ripple & noise are measured at 20MHz of bandwidth by using a 12" twisted pair-wire terminated with a 0.1uF & 47uF parallel capacitor. Tolerance: includes set up tolerance, line regulation and load regulation. Line regulation is measured from low line to high line at rated load. Load regulation is measured from 0% to 100% rated load Length of set up time is measured at cold first start, Turning ON/OFF the power supply very quickly may lead to increase of the set up time. The ambient temperature derating of 5°C/1000m is needed for operating altitude great than 2000m(6500ft). The power supply is considered a component which will be installed into a final equipment. All the EMC tests are been executed by mounting the unit on a 360mm*360mm metal plate with 1mm of thickness. The final equipment must be re-confirmed that it still meets EMC directives. 			

Mechanical specification

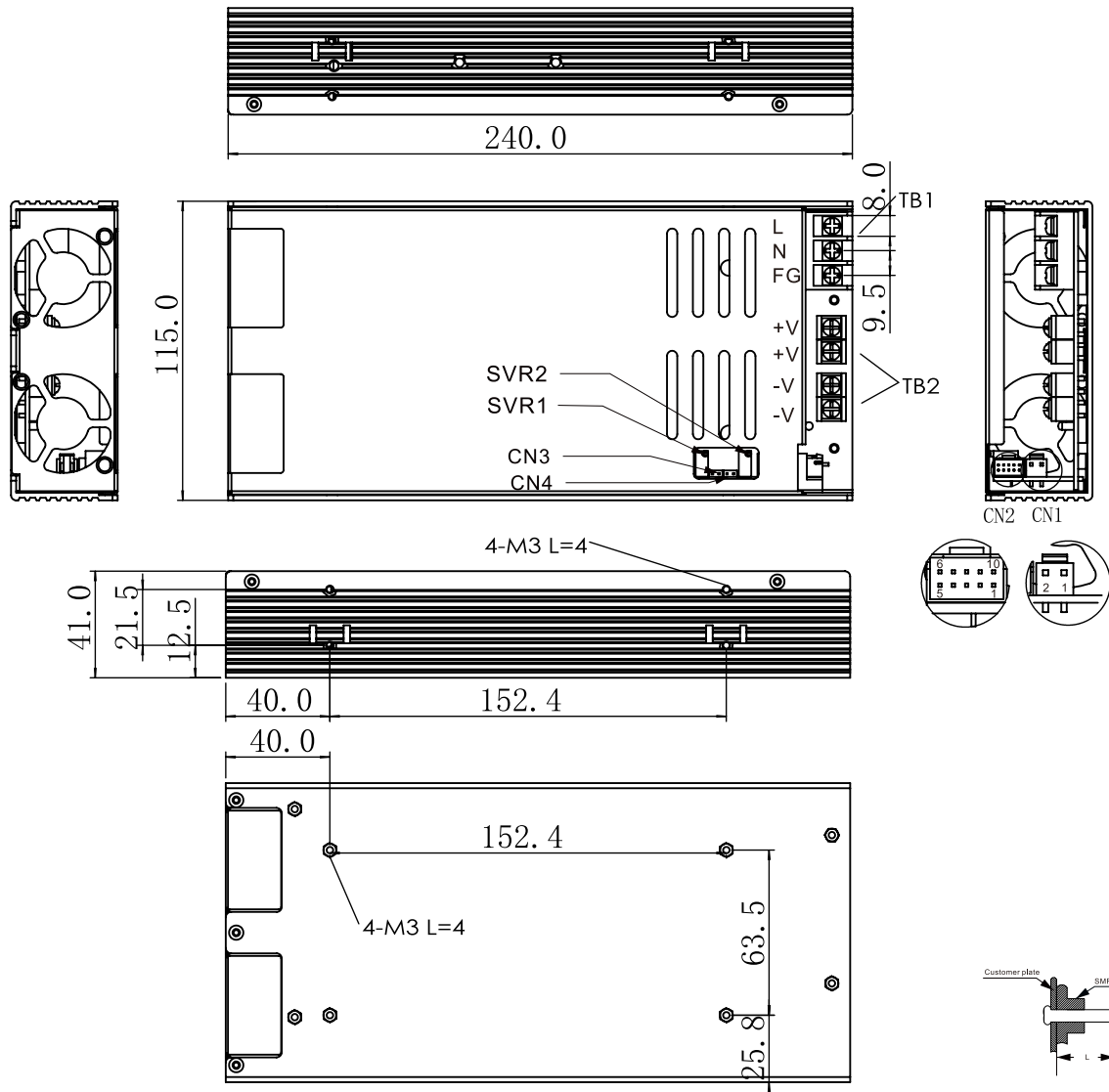

Terminal	Functional description											
TB1	Input Terminal											
TB2	Output Terminal											
CN1	Terminal: A3693WR-2P The 75W auxiliary power was isolated with main output, output: 24V/3.13A tolerance±2% The auxiliary power output voltage also can be customized.	PIN NO.	1	2								
		Assignment	AUX-	AUX+								
CN2	Terminal: CJT A2008WR-2X5P Refer to the Function Manual.	PIN NO.	1	2	3	4	5	6	7	8	9	10
		Assignment	VO-	VO-	VO-	RC-	RS-	RS+	RC+	DCOK	PV	PC
CN3	When users use PV function(2.5-6V), CN3 should not be shorted by jumper, SVR1 was unusable. When users don't use PV function, CN3 should be shorted by jumper, SVR1 was usable.											
CN4	When users use PC function(1-5V), CN4 should not be shorted by jumper, SVR2 was unusable.											
SVR1	When CN3 was shorted by jumper, the output voltage can be trimmed by SVR1											
SVR2	When CN4 was shorted by jumper, the maximum output current can be trimmed by SVR2											

Block diagram

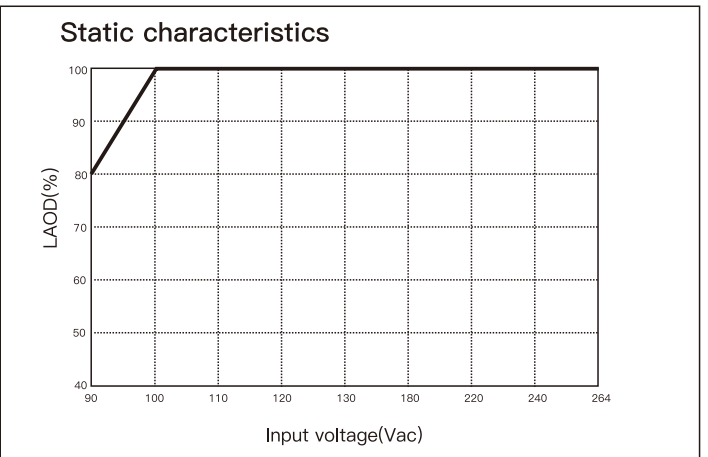
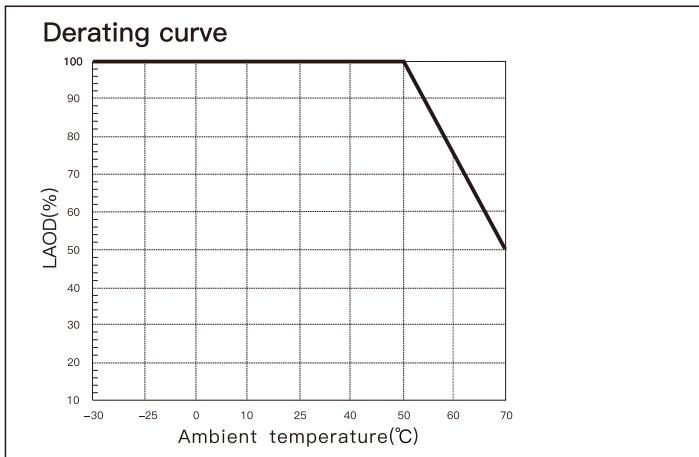
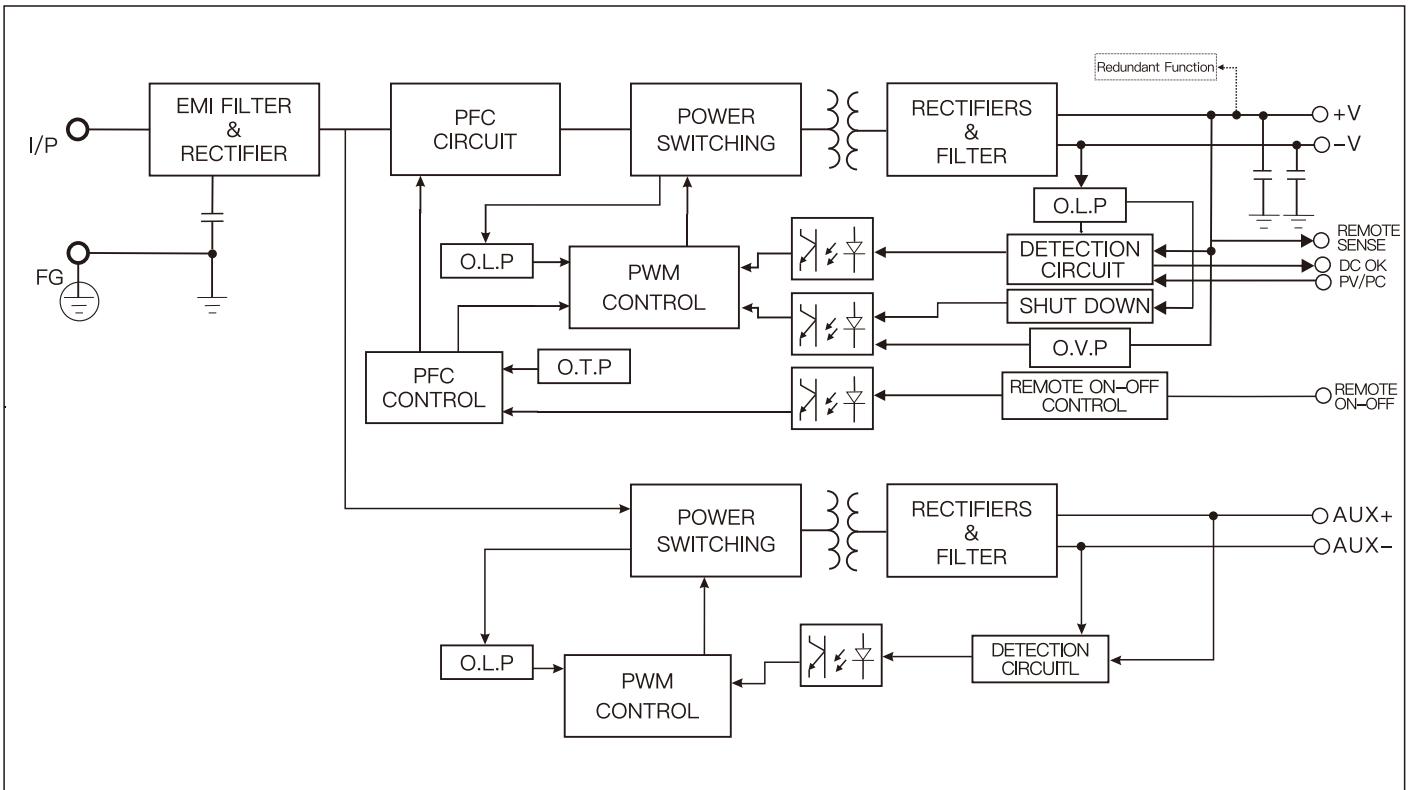

Redundant function

- 1, LP-1000R is built-in redundant function and can be connected 2 units in parallel
- 2, When in parallel operation, the maximum load should not be greater than the rated power of any PSU

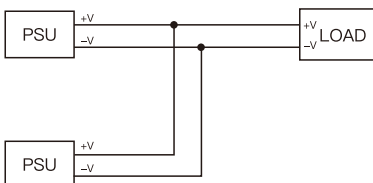

Output voltage programmable(PV)

Adjustment of output voltage is allowable to 50~120% of nominal output voltage, The output voltage can be trimmed by applying external voltage(2.5~6VDC). When users use PV function, CN3 should not be shorted by jumper.

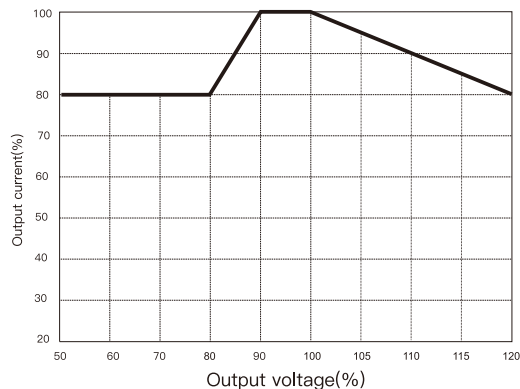
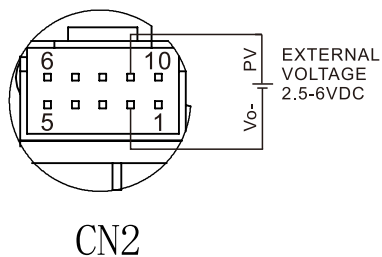
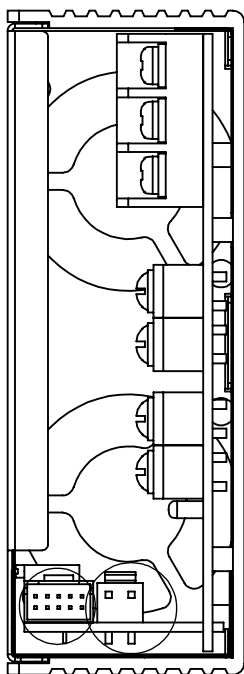

Output voltage vs PV voltage

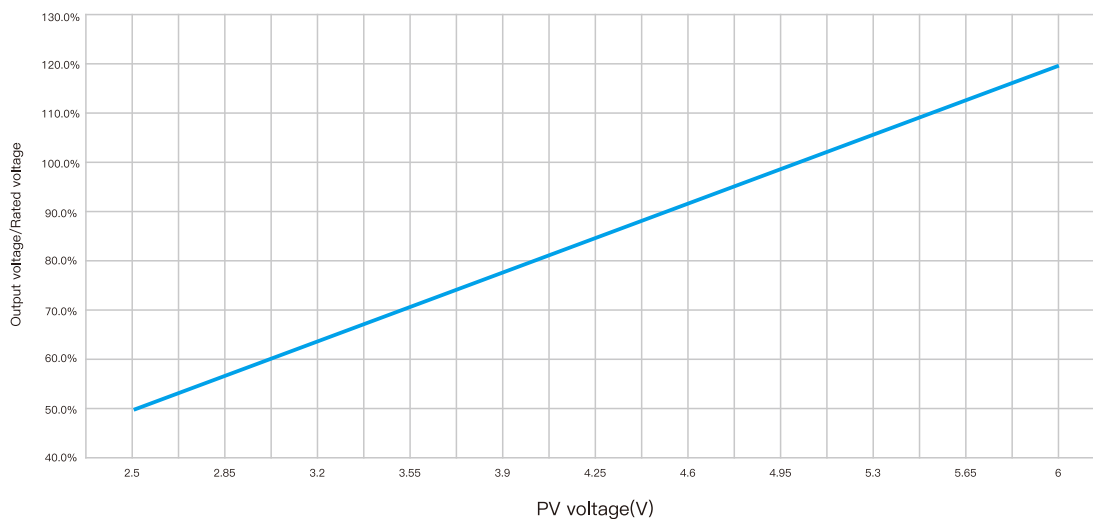

Output current programmable(PC)

Adjustment of constant current level is allowable to 20~100% of rated current, The output current can be trimmed by applying external voltage(1~5VDC). When users use PC function, CN4 should not be shorted by jumper.

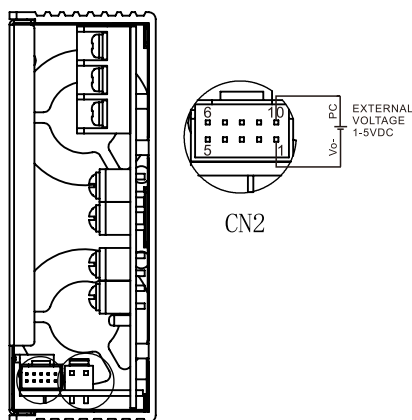

Output current vs PC voltage

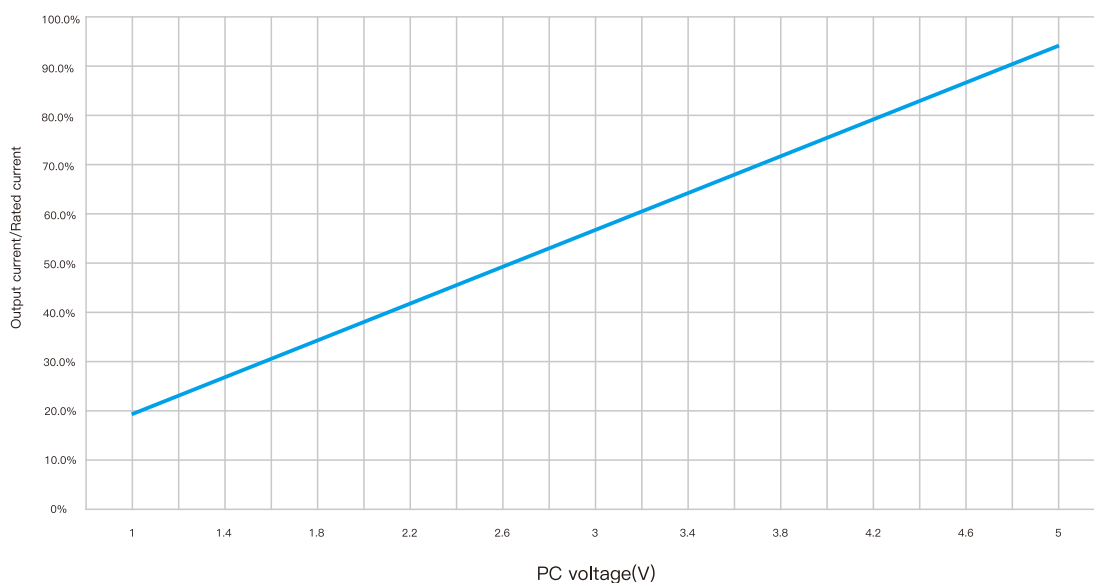

REMOTE CONTROL

The power supply can be turned ON/OFF by remote control voltage between RC+ and RC-. Power on: voltage between RC+ and RC- is 0~0.8V; Power off: voltage between RC+ and RC- is 4~10V.

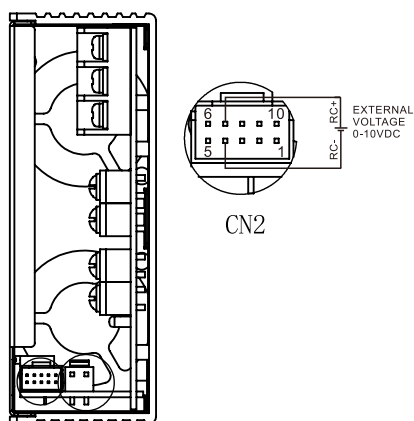

REMOTE SENSE

The remote sense Compensates voltage drop on the load wiring up to 0.3V.

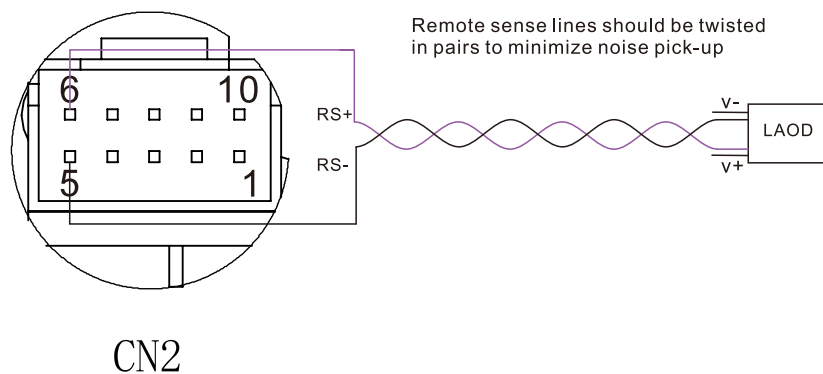
**DC OK**

Voltage between DC OK and VO- goes high after power set up; The voltage goes low when Vo below 80% of adj. voltage value. Internal pull-up voltage is 5.7V, internal pull-up resistor is 100Ω